

# CD4071B, CD4072B, CD4075B Types

## CMOS OR Gates

High-Voltage Types (20-Volt Rating)

CD4071B Quad 2-Input OR Gate  
CD4072B Dual 4-Input OR Gate  
CD4075B Triple 3-Input OR Gate

■ CD4071B, CD4072B, and CD4075B OR gates provide the system designer with direct implementation of the positive-logic OR function and supplement the existing family of CMOS gates. The CD4071, CD4072, and CD4075 types are supplied in 14-lead dual-in-line ceramic packages (D and F suffixes), 14-lead dual-in-line plastic packages (E suffix), and in chip form (H suffix).

### Features:

- Medium-Speed Operation- $t_{pLH}$ ,  $t_{pHL} = 60$  ns (typ.) at  $V_{DD} = 10$  V
- 100% tested for quiescent current at 20 V
- Maximum input current of  $1 \mu A$  at 18 V over full package-temperature range; 100 nA at 18 V and 25°C
- Standardized, symmetrical output characteristics
- Noise margin (over full package temperature range)
  - 1 V at  $V_{DD} = 5$  V
  - 2 V at  $V_{DD} = 10$  V
  - 2.5 V at  $V_{DD} = 15$  V
- 5-V, 10-V, and 15-V parametric ratings
- Meets all requirements of JEDEC Tentative Standard No. 13B, "Standard Specifications for Description of 'B' Series CMOS Devices"

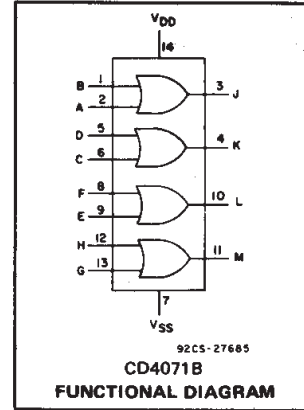

### RECOMMENDED OPERATING CONDITIONS

For maximum reliability, nominal operating conditions should be selected so that operation is always within the following ranges:

CHARACTERISTIC	LIMITS		UNITS
	MIN.	MAX.	
Supply-Voltage Range (For $T_A$ = Full Package-Temperature Range)	3	18	V

### STATIC ELECTRICAL CHARACTERISTICS

CHARACTERISTIC	CONDITIONS			LIMITS AT INDICATED TEMPERATURES (°C)							UNITS
	$V_O$ (V)	$V_{IN}$ (V)	$V_{DD}$ (V)	-55	-40	+85	+125	+25			
								Min.	Typ.	Max.	
Quiescent Device Current, $I_{DD}$ Max.	-	0.5	5	0.25	0.25	7.5	7.5	-	0.01	0.25	$\mu A$
	-	0.10	10	0.5	0.5	15	15	-	0.01	0.5	
	-	0.15	15	1	1	30	30	-	0.01	1	
	-	0.20	20	5	5	150	150	-	0.02	5	
Output Low (Sink) Current $I_{OL}$ Min.	0.4	0.5	5	0.64	0.61	0.42	0.36	0.51	1	-	mA
	0.5	0.10	10	1.6	1.5	1.1	0.9	1.3	2.6	-	
	1.5	0.15	15	4.2	4	2.8	2.4	3.4	6.8	-	
Output High (Source) Current, $I_{OH}$ Min.	4.6	0.5	5	-0.64	-0.61	-0.42	-0.36	-0.51	-1	-	mA
	2.5	0.5	5	-2	-1.8	-1.3	-1.15	-1.6	-3.2	-	
	9.5	0.10	10	-1.6	-1.5	-1.1	-0.9	-1.3	-2.6	-	
	13.5	0.15	15	-4.2	-4	-2.8	-2.4	-3.4	-6.8	-	
Output Voltage: Low-Level, $V_{OL}$ Max.	-	0.5	5	0.05				-	0	0.05	V
	-	0.10	10	0.05				-	0	0.05	
	-	0.15	15	0.05				-	0	0.05	
Output Voltage: High-Level, $V_{OH}$ Min.	-	0.5	5	4.95				4.95	5	-	V
	-	0.10	10	9.95				9.95	10	-	
	-	0.15	15	14.95				14.95	15	-	
Input Low Voltage, $V_{IL}$ Max.	0.5, 4.5	-	5	1.5				-	-	1.5	V
	1, 9	-	10	3				-	-	3	
	1.5, 13.5	-	15	4				-	-	4	
Input High Voltage, $V_{IH}$ Min.	4.5	-	5	3.5				3.5	-	-	V
	9	-	10	7				7	-	-	
	13.5	-	15	11				11	-	-	
Input Current $I_{IN}$ Max.		0.18	18	$\pm 0.1$	$\pm 0.1$	$\pm 1$	$\pm 1$	-	$\pm 10^{-5}$	$\pm 0.1$	$\mu A$

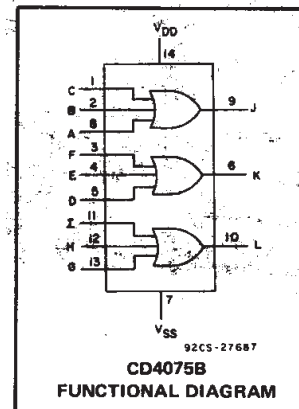
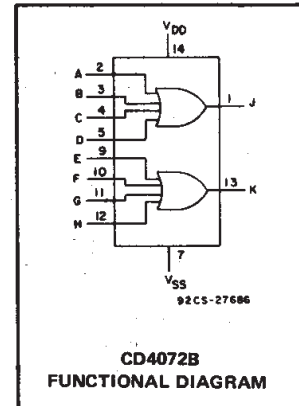

# CD4071B, CD4072B, CD4075B Types

## MAXIMUM RATINGS, Absolute-Maximum Values:

### DC SUPPLY-VOLTAGE RANGE, ( $V_{DD}$ )

Voltages referenced to  $V_{SS}$  Terminal ..... -0.5V to +20V

INPUT VOLTAGE RANGE, ALL INPUTS ..... -0.5V to  $V_{DD}$  +0.5V

DC INPUT CURRENT, ANY ONE INPUT .....  $\pm 10$ mA

### POWER DISSIPATION PER PACKAGE ( $P_D$ ):

For  $T_A = -55^\circ\text{C}$  to  $+100^\circ\text{C}$  ..... 500mW

For  $T_A = +100^\circ\text{C}$  to  $+125^\circ\text{C}$  ..... Derate Linearly at 12mW/ $^\circ\text{C}$  to 200mW

### DEVICE DISSIPATION PER OUTPUT TRANSISTOR

FOR  $T_A = \text{FULL PACKAGE-TEMPERATURE RANGE (All Package Types)}$  ..... 100mW

OPERATING-TEMPERATURE RANGE ( $T_A$ ) .....  $-55^\circ\text{C}$  to  $+125^\circ\text{C}$

STORAGE TEMPERATURE RANGE ( $T_{stg}$ ) .....  $-65^\circ\text{C}$  to  $+150^\circ\text{C}$

### LEAD TEMPERATURE (DURING SOLDERING):

At distance  $1/16 \pm 1/32$  inch ( $1.59 \pm 0.79$ mm) from case for 10s max .....  $+265^\circ\text{C}$



Fig. 1 - Typical voltage transfer characteristics.

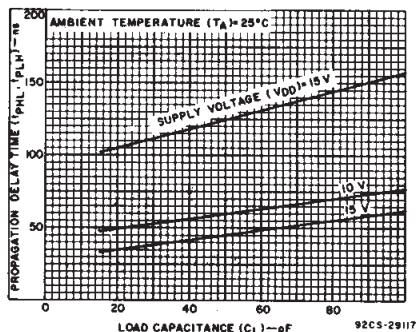

Fig. 2 - Typical propagation delay time as a function of load capacitance.

DYNAMIC ELECTRICAL CHARACTERISTICS at  $T_A = 25^\circ\text{C}$ , Input  $t_r, t_f = 20$  ns, and  $C_L = 50$  pF,  $R_L = 200$  k $\Omega$

CHARACTERISTIC	TEST CONDITIONS	ALL TYPES LIMITS			UNITS
		$V_{DD}$ VOLTS	TYP.	MAX.	
Propagation Delay Time, $t_{PHL}, t_{PLH}$		5	125	250	ns
		10	60	120	
		15	45	90	
Transition Time, $t_{THL}, t_{TLH}$		5	100	200	ns
		10	50	100	
		15	40	80	
Input Capacitance, $C_{IN}$	Any Input	—	5	7.5	pF



Fig. 3 - Schematic diagram for CD4071B (1 of 4 identical gates).

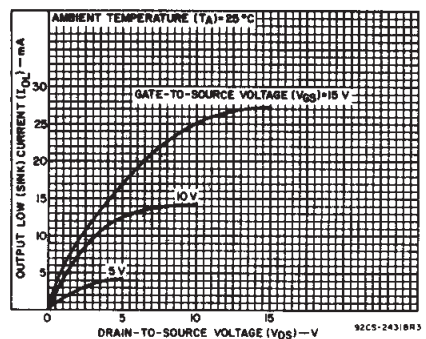

Fig. 4 - Typical output low (sink) current characteristics.

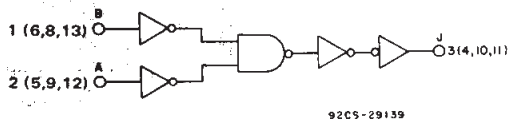

Fig. 5 - Logic diagram for CD4071B (1 of 4 identical gates).

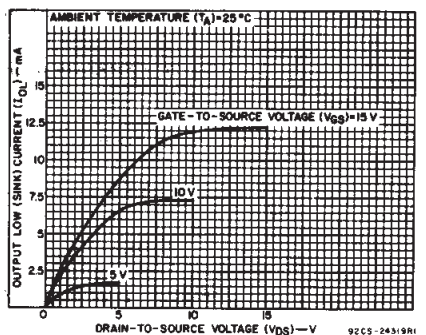

Fig. 6 - Minimum output low (sink) current characteristics.

3  
COMMERCIAL CMOS  
HIGH VOLTAGE ICs

# CD4071B, CD4072B, CD4075B Types



\* INVERTERS 2,3 AND 4 ARE IDENTICAL TO INVERTER 1.  
**Fig. 7 — Schematic diagram for CD4072B (1 of 2 identical gates).**



**Fig. 9 — Logic diagram for CD4072B (1 of 2 identical gates).**



**Fig. 11 — Schematic diagram for CD4075B (1 of 3 identical gates).**



**Fig. 13 — Logic diagram for CD4075B (1 of 3 identical gates).**



**Fig. 8 — Typical output high (source) current characteristics.**

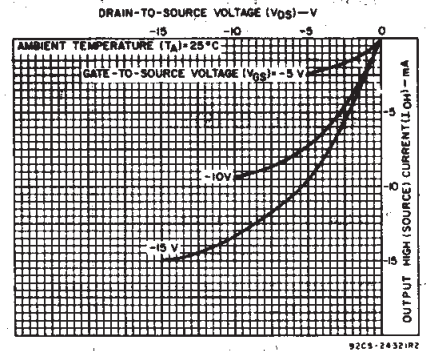

**Fig. 10 — Minimum output high (source) current characteristics.**



**Fig. 12 — Typical transition time as a function of load capacitance.**



**Fig. 14 — Typical dynamic power dissipation as a function of frequency.**

# CD4071B, CD4072B, CD4075B Types

## TERMINAL ASSIGNMENTS (TOP VIEW)

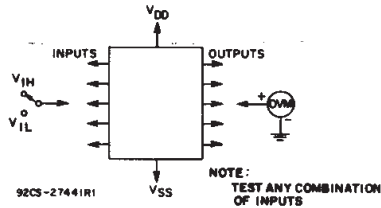
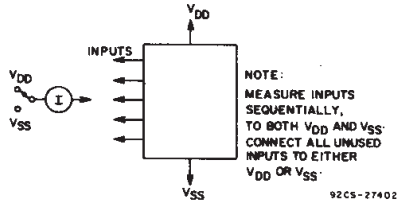
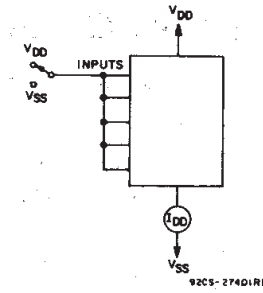
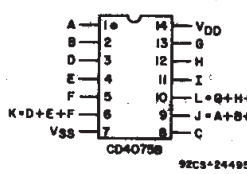
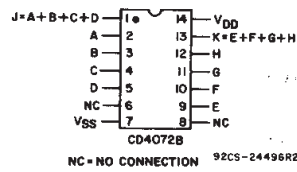
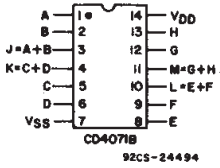
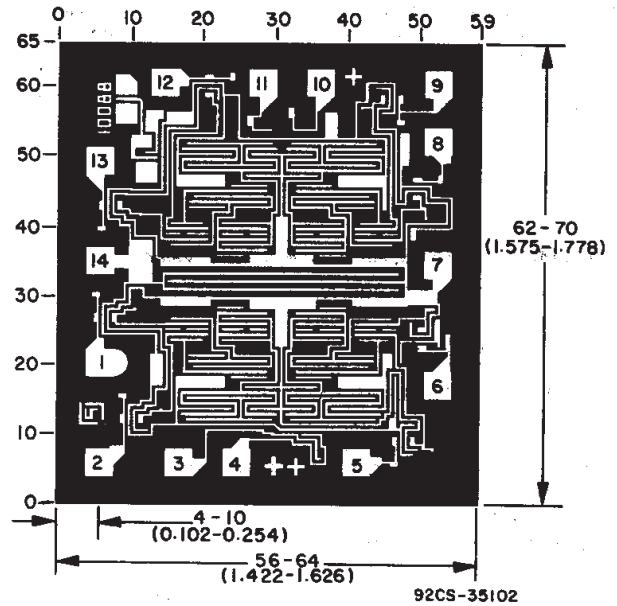
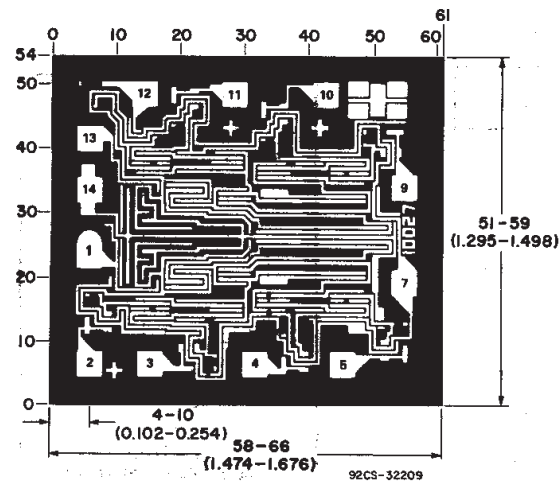

Fig. 17 - Input-voltage test circuit.

Dimensions in parentheses are in millimeters and are derived from the basic inch dimensions as indicated. Grid graduations are in mils (10<sup>-3</sup> inch).



Chip dimensions and pad layout for CD4071B.



Chip dimensions and pad layout for CD4072B.

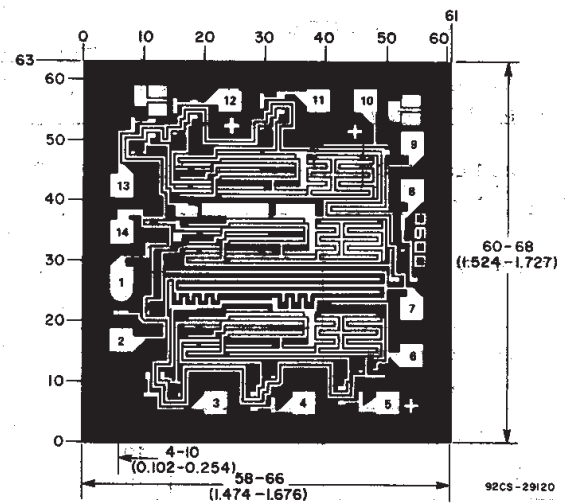

Chip dimensions and pad layout for CD4075B.

3  
COMMERCIAL CMOS  
HIGH VOLTAGE ICs

## **IMPORTANT NOTICE**

Texas Instruments and its subsidiaries (TI) reserve the right to make changes to their products or to discontinue any product or service without notice, and advise customers to obtain the latest version of relevant information to verify, before placing orders, that information being relied on is current and complete. All products are sold subject to the terms and conditions of sale supplied at the time of order acknowledgement, including those pertaining to warranty, patent infringement, and limitation of liability.

TI warrants performance of its semiconductor products to the specifications applicable at the time of sale in accordance with TI's standard warranty. Testing and other quality control techniques are utilized to the extent TI deems necessary to support this warranty. Specific testing of all parameters of each device is not necessarily performed, except those mandated by government requirements.

**CERTAIN APPLICATIONS USING SEMICONDUCTOR PRODUCTS MAY INVOLVE POTENTIAL RISKS OF DEATH, PERSONAL INJURY, OR SEVERE PROPERTY OR ENVIRONMENTAL DAMAGE ("CRITICAL APPLICATIONS"). TI SEMICONDUCTOR PRODUCTS ARE NOT DESIGNED, AUTHORIZED, OR WARRANTED TO BE SUITABLE FOR USE IN LIFE-SUPPORT DEVICES OR SYSTEMS OR OTHER CRITICAL APPLICATIONS. INCLUSION OF TI PRODUCTS IN SUCH APPLICATIONS IS UNDERSTOOD TO BE FULLY AT THE CUSTOMER'S RISK.**

In order to minimize risks associated with the customer's applications, adequate design and operating safeguards must be provided by the customer to minimize inherent or procedural hazards.

TI assumes no liability for applications assistance or customer product design. TI does not warrant or represent that any license, either express or implied, is granted under any patent right, copyright, mask work right, or other intellectual property right of TI covering or relating to any combination, machine, or process in which such semiconductor products or services might be or are used. TI's publication of information regarding any third party's products or services does not constitute TI's approval, warranty or endorsement thereof.